

PL> INSTRUKCJA MONTAŻU
D >MONTAGEANLEITUNG
GB>ASSEMBLY INSTRUCTIONS

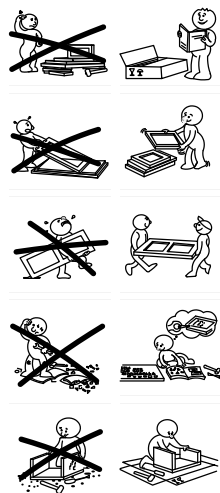

Czas montażu
Montagezeit
Time to assemble

3 hours
 3 zeit
 3 godz.

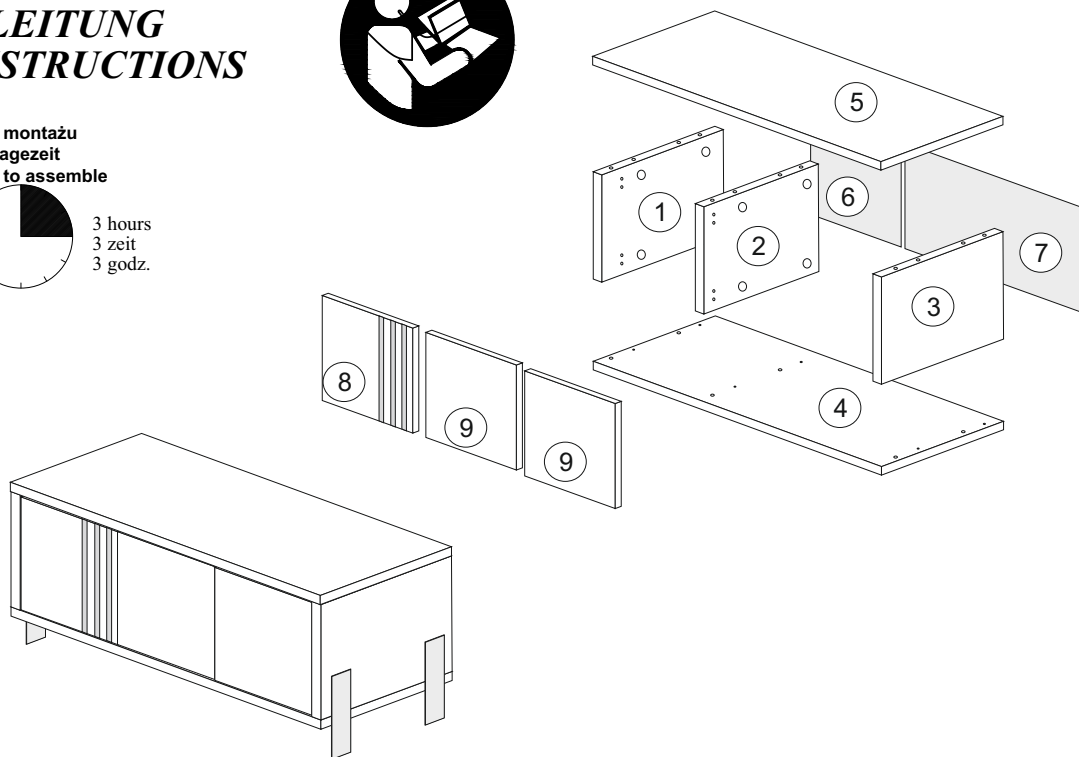

Uwaga / Achtung / Caution

PL>Czyszczenie należy wykonać wyłącznie za pomocą ściereczki lub lekko nawilżonego ręcznika.
 Nie stosować środków czyszczących do szorowania.

Szanowny kliencie, jeśli podczas montażu stwierdzisz uszkodzenie lub brak części, proszę podaj jej kod alfanumeryczny lub zaznacz ją na instrukcji montażu i prześlij wraz z protokołem reklamacyjnym

D >Bitte nur mit einem Staubtuch oder leicht feuchtem Lappen reinigen. Keine scheuerenden Putzmittel verwenden.

Sehr geehrter kunde, sollte ein teil fehlen oder beschadigt sein, kreuzen sie dies bitte deutlich auf der montageanleitung an und schicken sie die montageanleitung mit ein.

GB> Please be advised wardrobe must be build on the floor flat. Any missing pieces or damages please contact us for assistance. To clean please use warm water and soft cloth. Wardrobe can be moved only without the doors. If you attempt to moving the wardrobe with the doors installed please note you risking damaging it.

Karta serwisowa /Service Karte /Service card

AKCESORIA / ZUBEHÖR / ACCESSORIES

B x12	C x12	D x12	H x1	I x4	G x3	W2 4x20 x12
E x6	W1 3,5x16 x12					

I

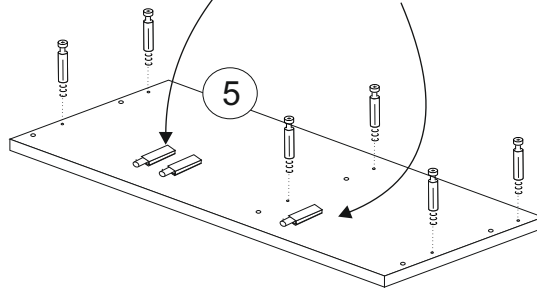
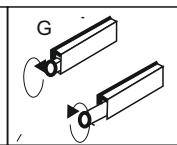
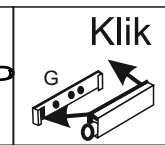
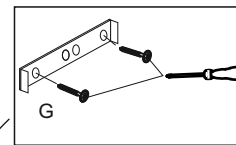
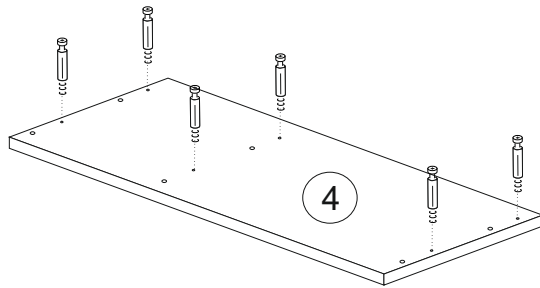
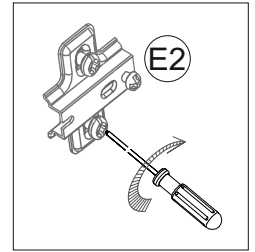
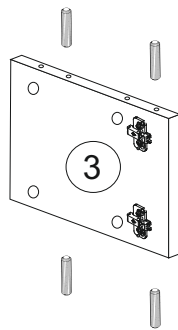
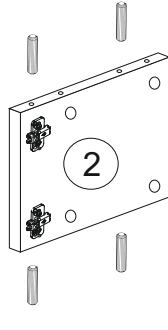
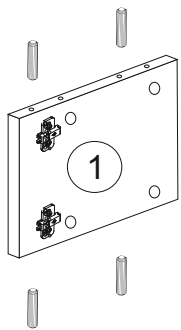
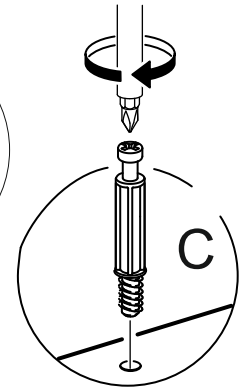
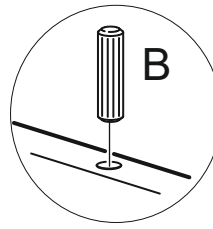
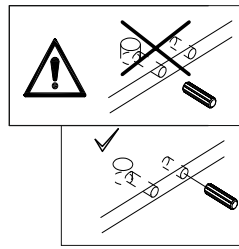
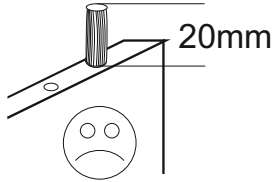
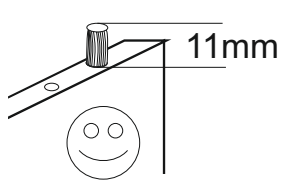

II

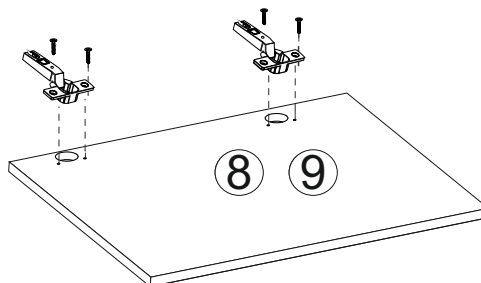
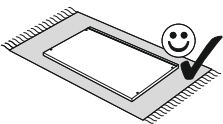
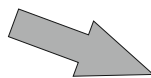
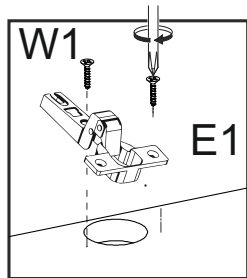

III

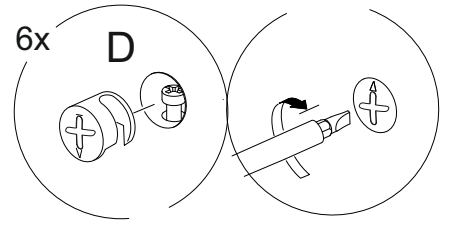
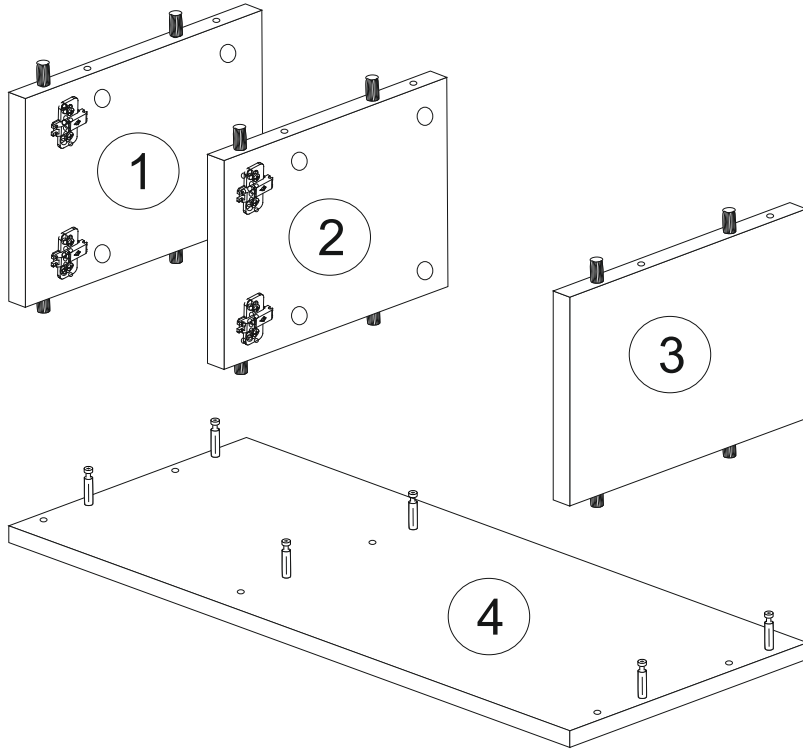

IV

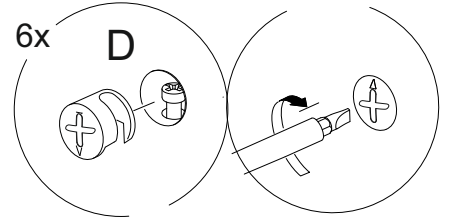
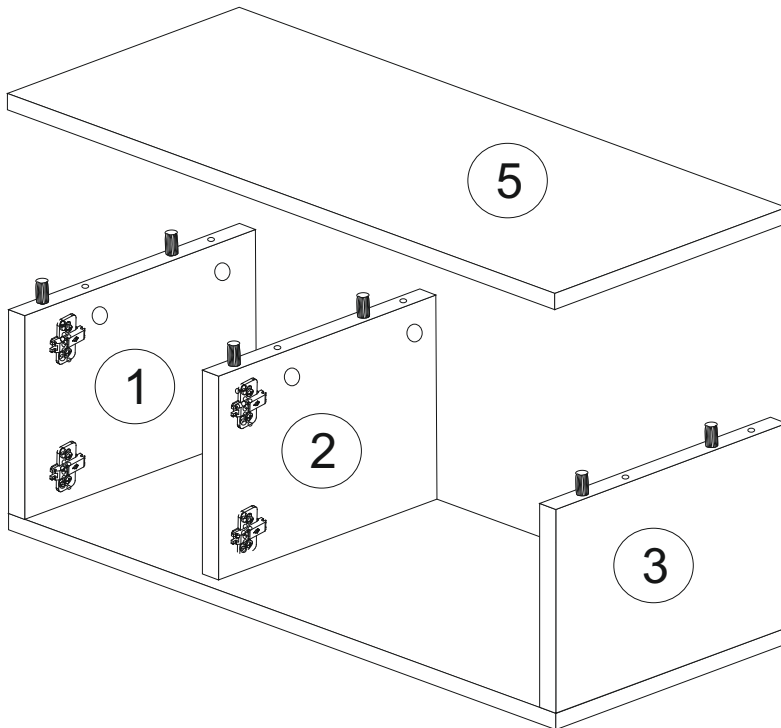

V

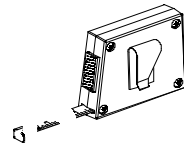
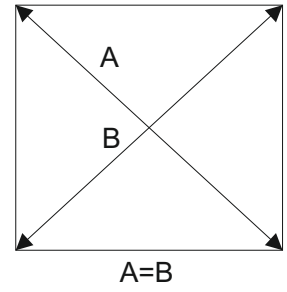
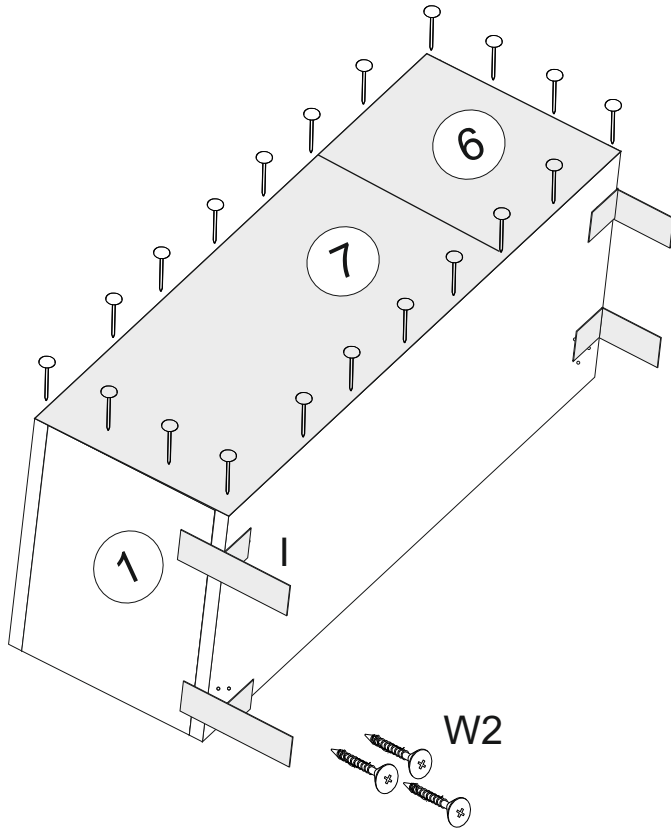

VI

